

Mikron

MILLS

400 / 400 U / 500
600 / 600 U / 800



Becoming better every day – since 1802

GF Machining Solutions

When all you need is everything, it's good to know that there is one company that you can count on to deliver complete solutions and services. From unmatched Electrical Discharge Machining (EDM), Laser texturing, Laser micromachining, Additive Manufacturing and first-class Milling and Spindles to Tooling and Automation, all of our solutions are backed by unrivaled Customer Services and expert GF Machining Solutions training. Our AgieCharmilles, Microlution, Mikron Mill, Liechti, Step-Tec and System 3R technologies help you raise your game—and our digital business solutions for intelligent manufacturing, offering embedded expertise and optimized production processes across all industries, increase your competitive edge.

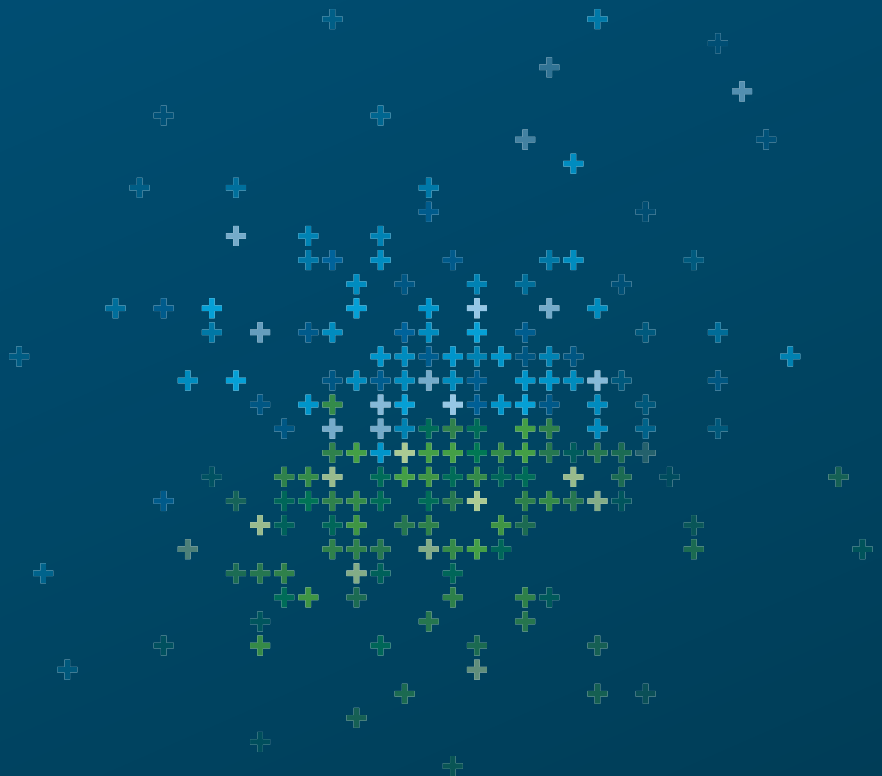

+ We are Mikron Mill.
We are GF Machining Solutions.

Contents

4	Market segments and applications
6	Technology / Solutions
8	Ambient Robust
10	Heidenhain TNC 640 control
11	smart machine
12	Accuracy
14	High-tech motor Spindles
15	Tool monitoring
16	Table variants, Tooling and Automation
18	Tool magazine
19	Chip, mist and dust management
23	Additive Manufacturing - for mold inserts
24	For a single machine with integrated Automation
25	For multiple machine integration in a cell line
26	Our Service + Success range
<hr/>	
28	Technical data
31	Customer Services
32	GF Machining Solutions

For more than 20 years, GF Machining Solutions has been pioneering the High Speed Milling (HSM) technology with its GF Mikron machines. The Mikron MILL S series is the result of this continuous development and brings together the utmost features that make it the reference solution within the industry.

The Mikron MILL S are 3-Axis and 5-Axis sensational High Speed Milling solutions for mold and die manufacturers.

3-Axis applications



Watch



ICT



Machining



Electronic





5-Axis applications

Packaging



Infrastructure



Automotive

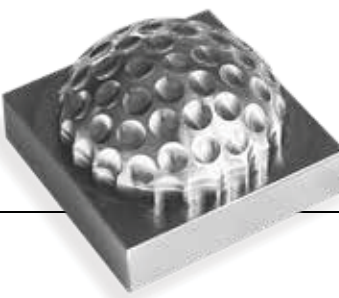

**Fast Moving
Customer Goods**



Technology

High-speed milling: precision and quality for tool- and moldmaking



- + Precision
- + Fastest process speed
- + Best surface finish

**“The best
arguments
are just
best results”**

We have the right solution - for you

- + Reliable process due to sophisticated thermal management system
- + Best damping characteristics due to mineral cast machine base
- + Direct linear and rotative drives for highest dynamic process
- + Unrivalled accessibility, with or without Automation
- + Integrated or third-party Automation in smallest footprint
- + smart machine modules for precision, protection, time and saving energy
- + Remote line assistance
- + Step-Tec Spindle
- + Heidenhain TNC 640 control



- Master the challenge of delivering speed and quality at the highest level
- Unbeatable flexibility in 3- and 5-Axis applications
- Advanced Milling solution to substitute or minimize subsequent process steps
- Highest productivity per square meter

Ambient Robust

Put a smile on mold and die makers' faces



1

Machine is in perfect condition - on time

Energy savings and highest accuracy right from the beginning.

Perfect starting position with Econowatt.



Warm up without losing time and save energy

2

Keep cool about precision

Highest mechanical requirements in combination with perfect machine calibration ensures the perfect basis for high-precision production.



Start the Milling process with required precision

3

Achieve precision despite variations in ambient temperature and speed

Process stability due to thermostabilized body.

Reduced production time with OSS extreme.



No negative impact due to ambient temperature

4

Unleash full performance at one finger tip

OSS extreme provides higher precision and surface quality.

Reliable milling process due to tool monitoring with ITM.



Fastest 5-Ax HSM precision solution

Precision over a long running times

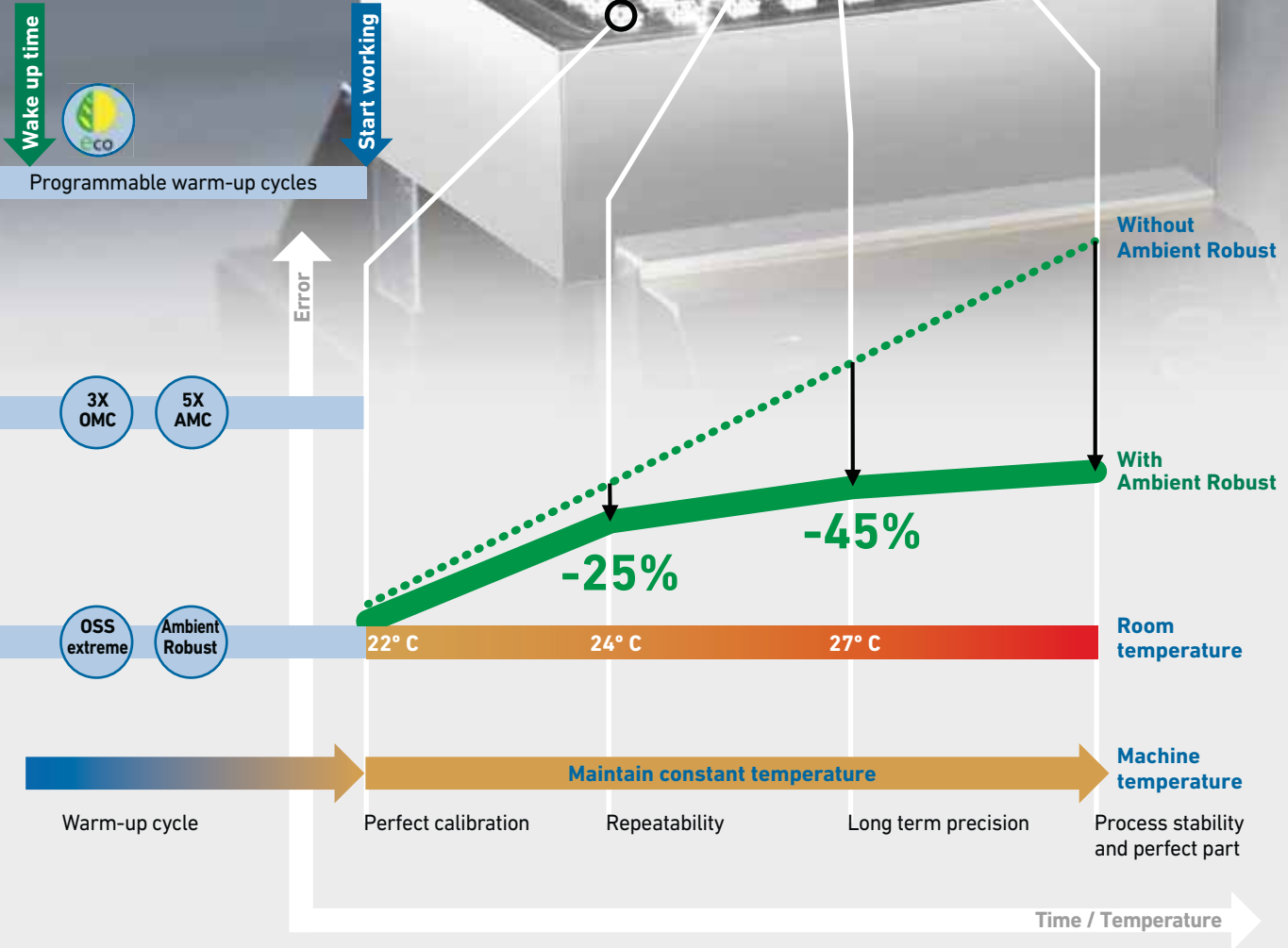

OSS extreme for higher precision, better surface quality and up to 25% shorter machining time

Better surface finish thanks to smoother movement (homogeneous colors).
 Reduced production time thanks to higher overall high federate (dark colors).

OSS extreme **ITM**

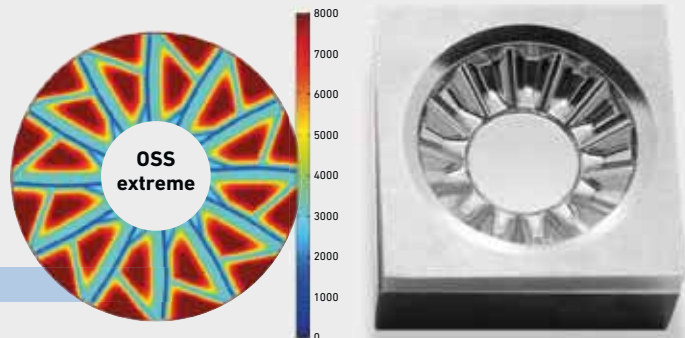

Heidenhain TNC 640 control

Optimal machining efficiency is at your fingertip

The Heidenhain TNC 640 control provides flexibility and efficiency from job preparation until part is milled. Mounted on a pivot arm to give more operator's accessibility, the touchable screen allows the operator to quickly navigate through the control. Thanks to a user-friendly and practical interface in combination with several functionalities, the TNC 640 support operators in their daily job giving to them more availability for other tasks.



AMC/OMC

Higher precision from the beginning



AMC

Every MILL S 5 axis machine is featuring the new Automated Machine Calibration (AMC). This new calibration tool comes with the complete Calibration Hardware on a pallet and allows calibrating at any time the kinematic of the machine. Program it or release it manually simply by pressing the start button. Beside the machine kinematic, it will also automatically calibrate touch probe and tool measuring system when needed.



OMC

Every MILL S 3-axis machine is delivered with OMC (Original Manufacturer Calibration). Performed at the original assembly within GF production plant it is a new sequence of the calibration process reducing the machine tolerance. Achieving tight geometric dimensioning and tolerances will be easier.

smart machine

Enhance your process beyond program and machine setup

The smart machine functionalities gathers a range of modules that offers various features in order to make the Milling process "intelligent,"

Each of the modules fulfills a specific task. Just like in a construction kit, the user can select the modules that seem to him to be the best option for improving his process.

- Produce your workpieces in a process-secure and precise manner
- Increase reliability in unmanned operation
- Boost the service life of the machine
- Significantly reduce production costs

Saving energy

smart machine modules like Econowatt, saving up to 50% energy, are ecological necessities with attractive economic advantages.

Time

smart machine modules like OSS and software tools such as rConnect boost your productivity. OSS extreme yields up to 24 % more speed with improved surface finish and accuracy.



Precision

smart machine modules like ITC and OSS support the precise base of your machining center to achieve an even more precise final part.

Protection

smart machine modules like PFP protect and extend the lifetime of your machine and tools.

smart machine classic package

Find your market and tune your machine accordingly

With the new smm package for 3 axis and 5 axis machines GF Machining Solutions combines some of the most powerful smart machine modules for your targeted applications and market needs. This tuning package will support you to get the best out of your machines according to your customer base.

For the 5 axis machines the included AMC extended corrects beside any position errors of the 4th and 5th axis also the angle errors of the swivel and rotary axis.

Accuracy

HSM core components

+ Static accuracy

Perfect machine design with highest mechanical requirements provides the basis for a high-precision machine.

Moreover, GF Machining Solutions spares no effort to implement state-of-the-art components to create the best package for your Milling applications.

+ Dynamic accuracy

Stability, high dynamic drives and ingenious software are primary prerequisites for maximum precision and best workpiece surface quality.

- + Concrete polymer with high thermal inertia and excellent damping properties
- + Optimized force distribution within castings
- + High-precision direct drives and guides for high dynamics and rigidity
- + Direct path measuring system in the linear and rotational axis
- + Intelligent software compensation

+ Thermal accuracy

The Mikron MILL S series leads precision machining into a new era.

Sophisticated temperature management system comprises separate and independent cooling circuits of all heat sources and machine body as follows:

- + X, Y, Z, B, C drives
- + Machine body
- + Spindle with Opticool or CoolCore technology
- + Electronics cabinet

Highest part precision is the ultimate result of this solution's active stabilization enabling highest stability and process reliability.



Z

MILL S 400	360 mm
MILL S 400 U	360 mm
MILL S 500	360 mm
MILL S 600	500 mm
MILL S 600 U	500 mm
MILL S 800	500 mm

• Comprehensive and reliable Milling solution for mold and die applications as a result of machine design, core components and complete process know-how.

Y

MILL S 400	450 mm
MILL S 400 U	240 mm
MILL S 500	450 mm
MILL S 600	600 mm
MILL S 600 U	600 mm
MILL S 800	600 mm

Rotation axis n x 360°
Swivel axis +110°/-110°

X

MILL S 400	500 mm
MILL S 400 U	500 mm
MILL S 500	500 mm
MILL S 600	600 mm
MILL S 600 U	800 mm
MILL S 800	800 mm

HSM core components from Step-Tec

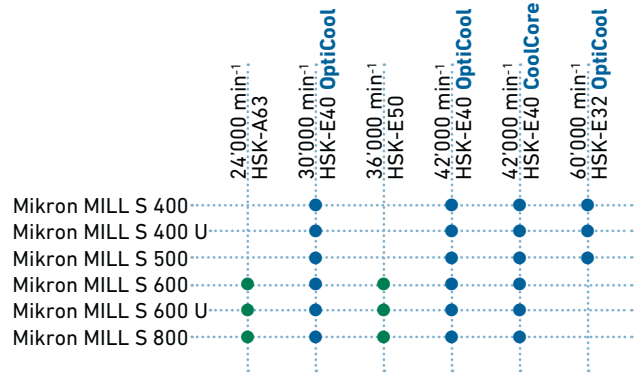

• Your reliable and stable Milling process is secured, thanks to an ingenious temperature control system

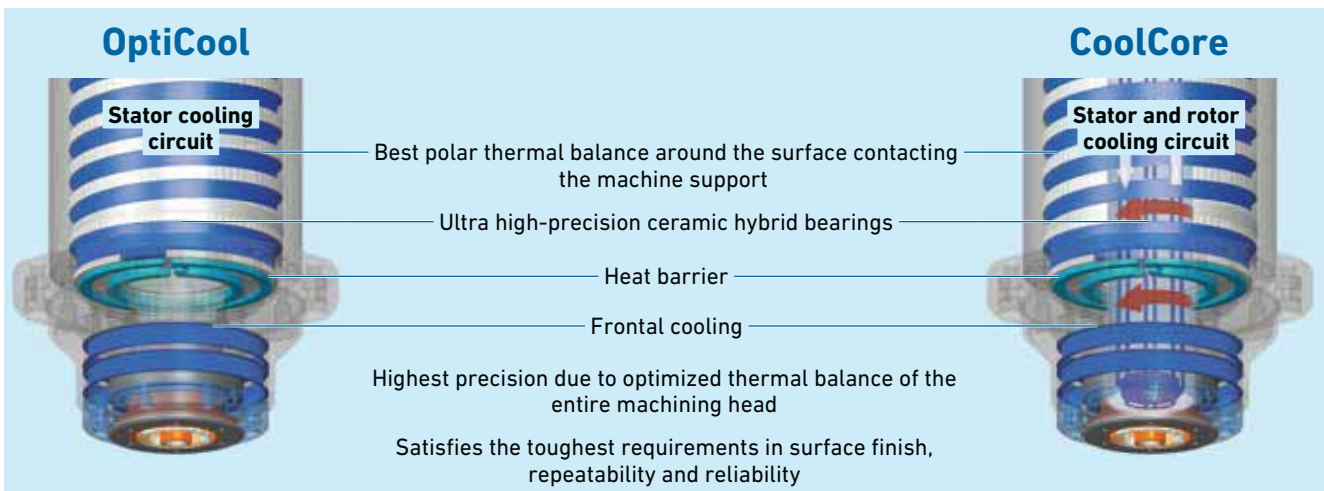

OptiCool

Step-Tec's OptiCool Spindle series ensures not only that the Spindle remains thermally stable, but that natural heat transfer to the Spindle support (e.g., Z axis) is limited to the lowest amount possible, in order to preserve the machine's geometry.

CoolCore

Where conventional stator cooling reaches its limits, Step-Tec's CoolCore Spindle goes beyond the ordinary to lower the temperature and minimize temperature fluctuations in the rotating shaft.

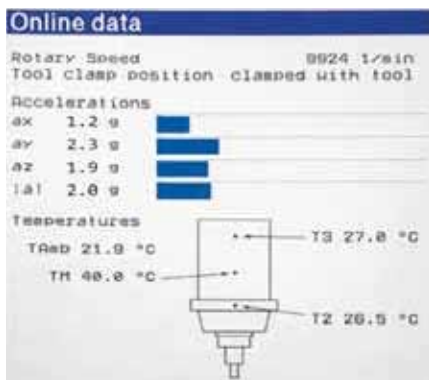

Cutting conditions monitoring

- + Vibration monitoring along each axis
- + Temperature monitoring of hot spots (bearings, motor, ambient temperature)

Additional advantages of CoolCore

- + Cooled shaft reduces the natural thermal shaft growth by half
- + Greatest thermostability and highest precision due to lower temperature fluctuations down to the tool tip
- + Significant reduction of thermal recovery time resulting in a productivity gain

Tool monitoring

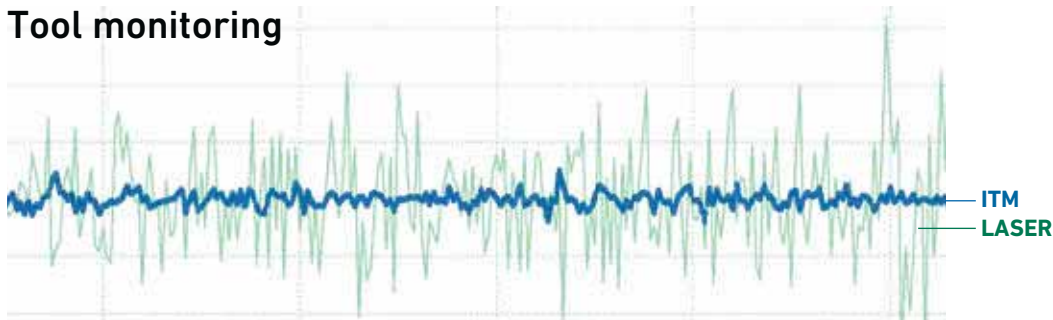

ITM: the breakthrough in tool measuring

ITM (Intelligent Tool Measurement)

Your production of high-precision parts depends on perfect tool monitoring. ITM improves your process reliability and reduces measurement uncertainties.

ITM tool measurement registers the entire tool tip up to $\varnothing 20$ mm (MILL S 4/500) / $\varnothing 40$ mm (MILL S 6/800) thanks to modern vision sensors. Special software digitally removes all tool contamination (e.g., drops, dirt, chips) and measures the captured tool geometry.

ITM makes it possible to measure tools on a GF Mikron machine with micrometer range repeatability.

Application to prove reliability of ITM

- Starting position at step 0 μm .
- Lift tool by 1 μm and mill orthogonal to the steps and observe the Milling marks on step 0 and +2 μm .
- Regardless of tool type, you see marks on step +2 μm and no marks on step 0 μm .
- This proves that ITM ensures a reliable and repeatable tool measuring accuracy of < 2 μm .

• Precise and stable production through accurate and reliable tool monitoring

Measuring process

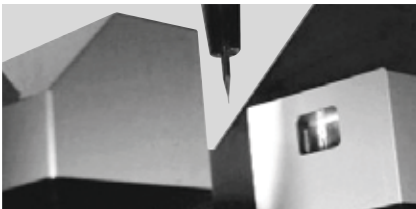

True tool measurement thanks to digital cleaning of foreign objects (particles and chips).

Partial tool breakage detection thanks to complete capture and control.

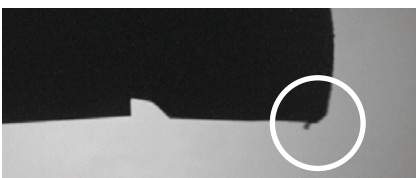

Measurement of smallest tool diameters

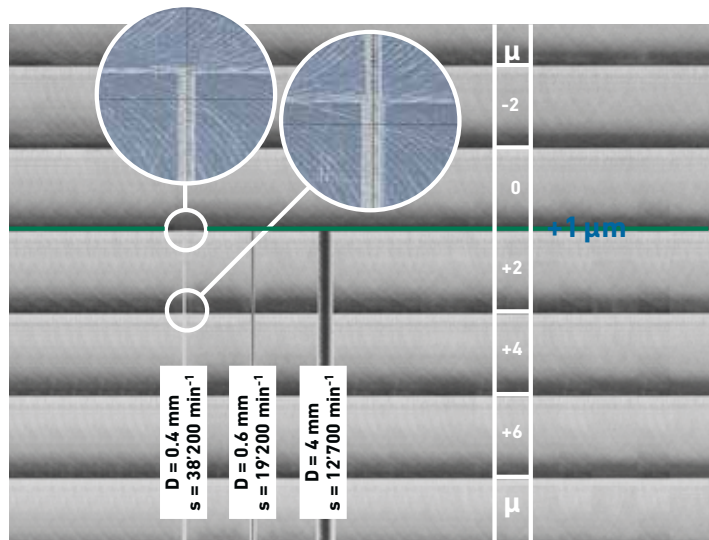
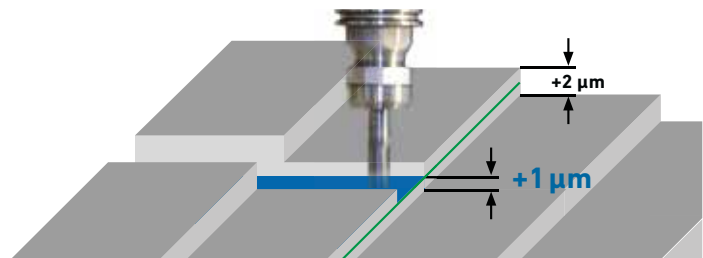
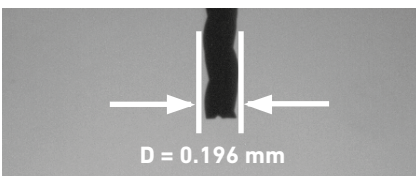

As flexible as needed

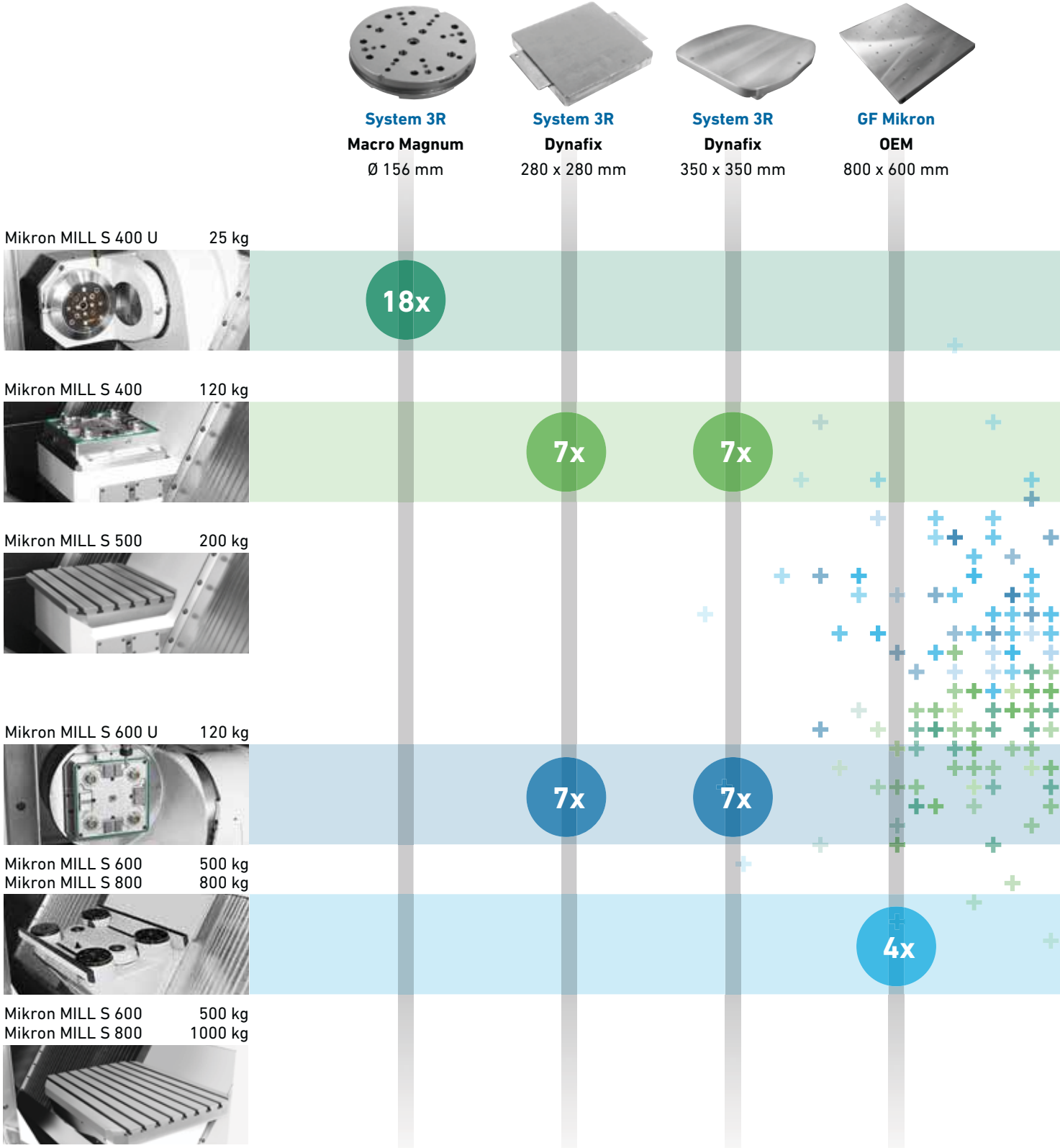

- Increase your productivity by reducing your setup time with a zero point clamping system
- Increase your quality by improving repeatability with tooling and Automation



**Erowa
ITS**
Ø 148 mm

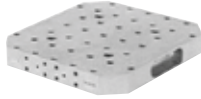

**Erowa
UPC**
320 x 320 mm

20x

7x

7x

Easy loading and unloading of pallet magazine during the machining process

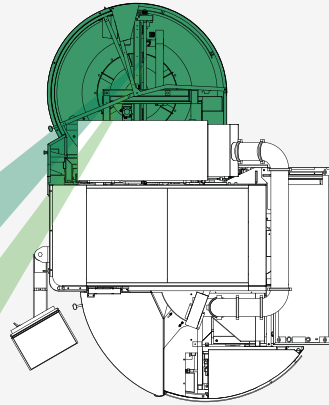

Mikron MILL S 400 / 400 U: disc-type magazine

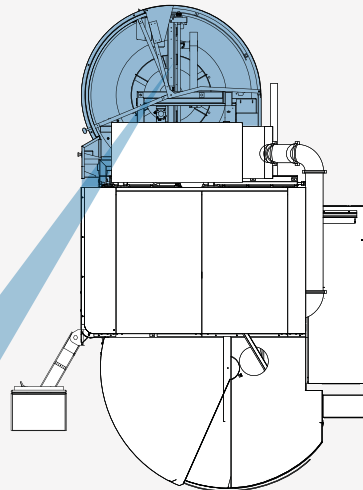

Mikron MILL S 600 U: disc-type magazine

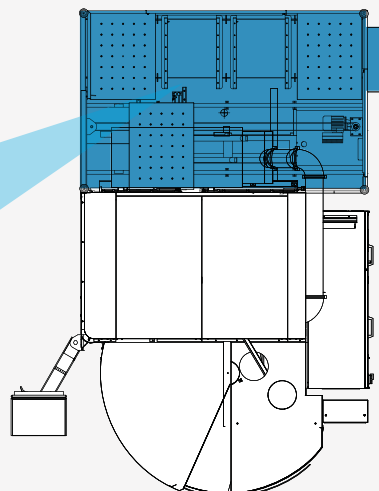

Mikron MILL S 600 / 800: linear-type magazine

Tool magazine

Double-row HSK-E40 magazine internal to the machine's standard footprint with a capacity of 68 tools.



Individual solutions tailored to your production needs

Tool Automation in every configuration level

- + Simple or double-row disc magazine
- + Reliable "pick-up" changing system
- + Feed control via light beam
- + Capacity of up to 68 tools with magazines internal to the machine's standard footprint
- + Orientation of the touch probe

Optionally available in a variety of capacities:

Mikron MILL S 400	Mikron MILL S 600
Mikron MILL S 400 U	Mikron MILL S 600 U
Mikron MILL S 500	Mikron MILL S 800
HSK-E40:	HSK-E50:
18; 36; 68 tools	15, 30, 60 tools
HSK-E32:	HSK-E40:
20; 40 tools	18; 36; 68 tools
	HSK-A63:
	48 tools

User-friendly tool feeding

- Productivity and process reliability are ensured by lateral tool feeding
- + Simultaneous machining and feeding
 - + Simple feed monitoring through large glass panel
 - + Ergonomic access



Chip, mist and dust management

Clean machining, wet or dry

Adapted chip, mist and dust management

The form and volume of the chips are determined by the machined material as well as the processing strategy. The options offered range from a coolant tank with chip flushing to models with cooling oil and coolant temperature stabilization.

Chip auger

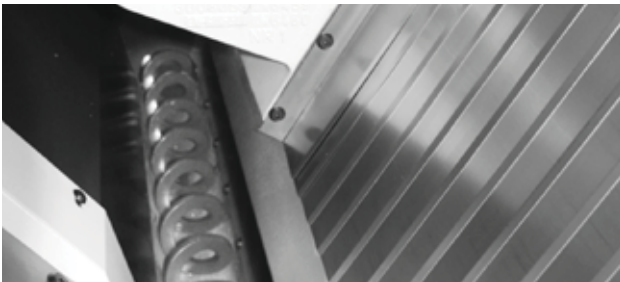

Coolant tank



Additionally mist and dust management systems are available according to your needs.

Graphite extraction with powerful suction system



Lift-up chip conveyor



- + Solution for aluminum milling chips. With slat band lift-up-chip-conveyor and coolant unit with fine-filtration
- + Solution for steel milling chips with scraper lift-up chip conveyor and coolant filtration unit

Basket or band filter system



Depending on machine equipment and processing strategy, 450- and 950-liter filter systems are available.

- + Pump back station
- + Lift pump station
- + Wash-down system



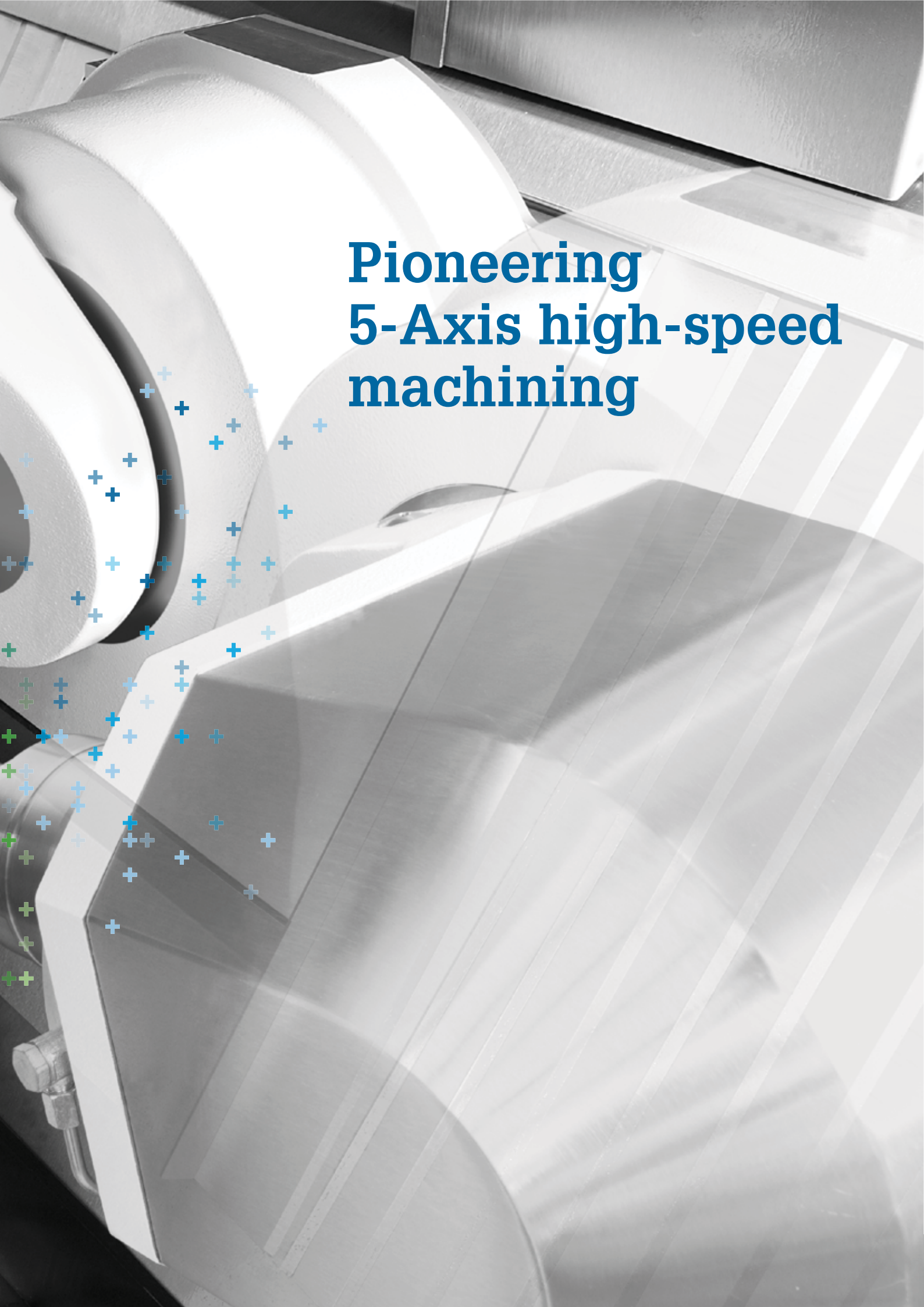

Pioneering 5-Axis high-speed machining

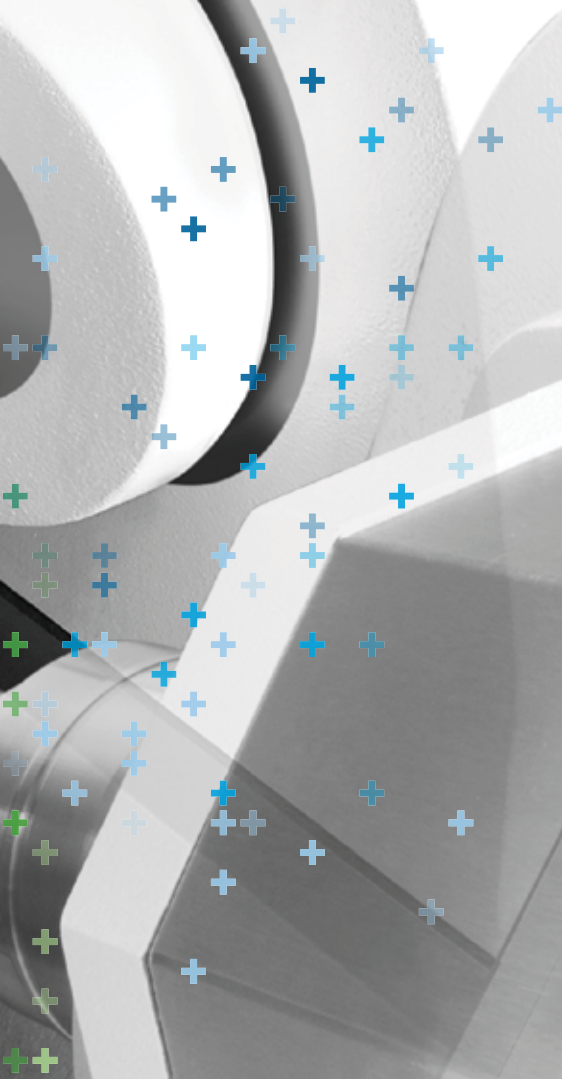

**We
deliver
best
results**

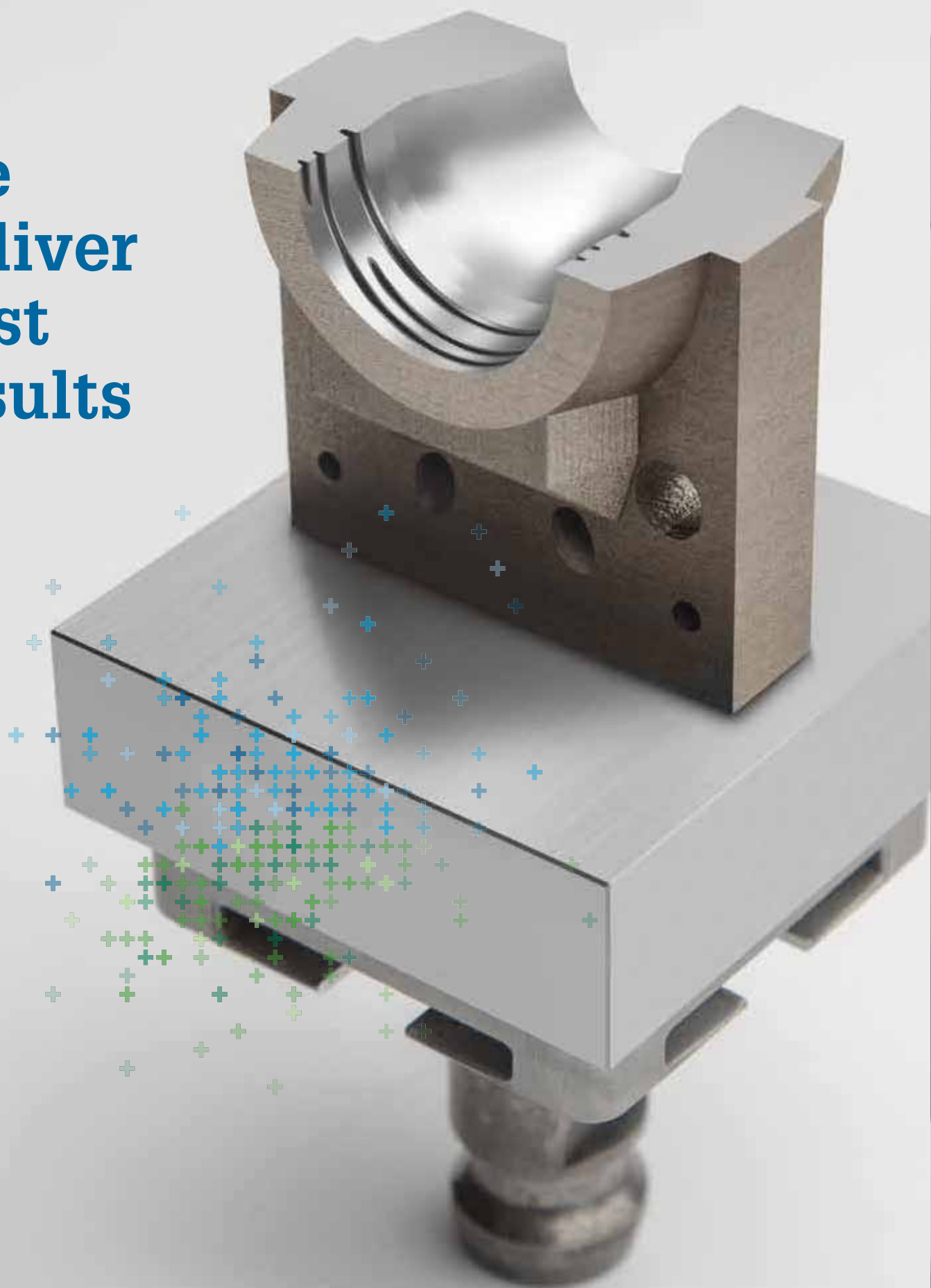

Additive Manufacturing - for mold inserts

Clever combine with other technologies



Efficient cooling channels
Additive Manufacturing



Perfect surface
HSC Milling / die sinking



Innovative product design
Laser texturing



Differences between conventional and conformal channels

Additive Manufacturing (AM) describes the technologies that build 3D objects by adding layer upon layer of material like plastic or metal.

AM equipment translates data from the computer-aided design (CAD) file and deposits successive layers to fabricate a 3D object.

GF Machining Solutions offers the DMP metal 3D printers to build 3D-printed mold inserts and develops solutions to integrate the machine in the whole manufacturing process chain.

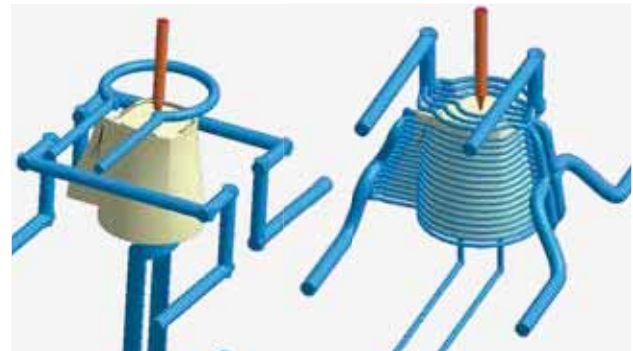

Conventional cooling

Tempering by conformal cooling channels

AM is uniquely suitable for the generation of 3D conformal cooling systems and adds the geometrically complex portion to the simple base manufactured using a Milling machining center.

The resulting hybrid mold insert is the most economical solution for parts characterized by geometrically simple and complex sections.

- Complete freedom of design of cooling channels
- Increased productivity of injection molding and die casting processes
- Improved quality of injected/cast parts



For a single machine with integrated Automation

Job Tool Manager (JTM) - bring agility back to the shop floor

User friendly software for one machine with integrated pallet changer. Assign NC programs to pallet position by drag and drop on a touch screen, close to the pallet changer.

Advantages

- + Easy to change priorities when the machine is working
- + Add or remove jobs while machining
- + Jobs where cutters are missing will not be started
- + Estimated and present machining time for the magazine content are calculated.

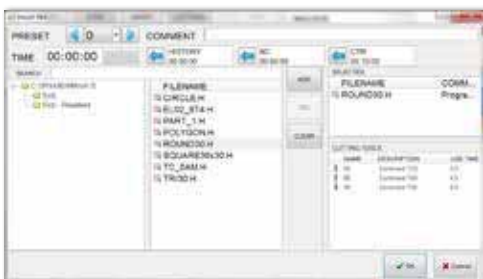
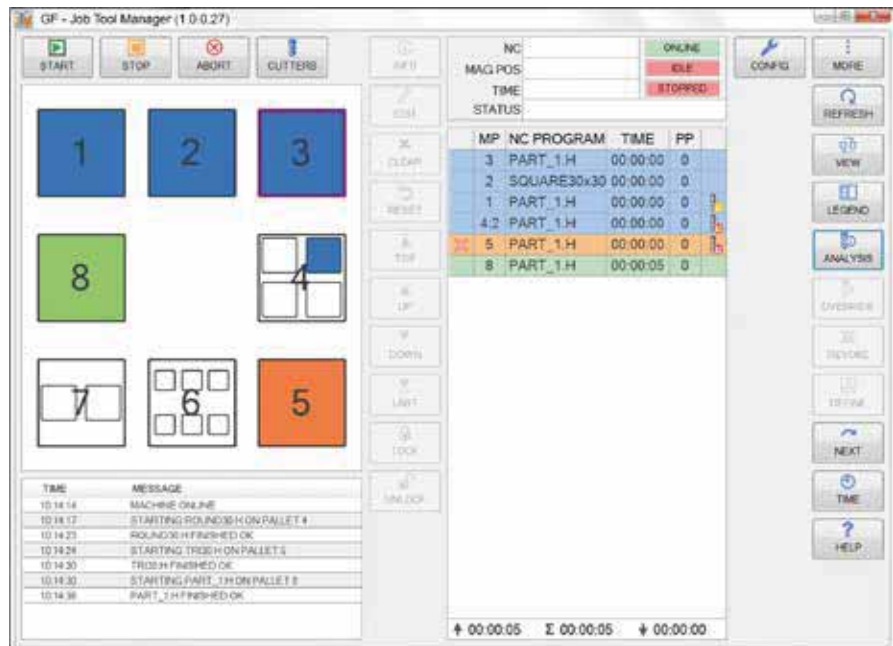

Assign NC file, check tool capacity, schedule

By selecting the NC program, Job Tool Manager registers the tools used in the program. Time is stored if the NC program defines the time for the entire machining or if each tool has its use time.

If the program has been used earlier, it automatically displays the last recorded time.



Manage tools upon jobs to be done

Each time a new job is started, Job Tool Manager checks the machine tool table to see the availability of tools. If a tool is broken and no sister tool is available, the job will be blocked.

For multiple machine integration in a cell line

Leverage cross technology, collaborative manufacturing and autonomy

Customized solutions

In addition to our portfolio of machines, customer-specific solutions are among our core competencies.

Let's talk about how we can take your operation to the next level.

Automation interface

Thanks to a standardized robot interface, the Mikron MILL S series can be linked to System 3R robot systems as well as operated with robot systems from other well-known suppliers.

Regardless of the handling system used, the machine offers comfortable accessibility when integrated into a line.



Our Service + Success range

We take you to new heights

Guiding your ascent

Whether it is Milling, EDM, Laser Texturing or Additive Manufacturing, our Service + Success experts guide you throughout the entire lifecycle of our Machining and Automation tools in order to help you reach your peak performance. Our trusted experts, backed by our latest cutting-edge, intelligent Digital Solutions, provide a full range of services.



Operational steering
Hands-on and operational service interventions with supply of consumables and wear parts.



Advanced diagnosis
Machine check-up, preventive maintenance and advanced services including original spare parts availability in all our hubs around the world

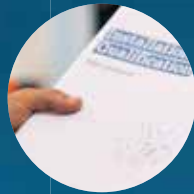

Certification
State-of-the-art certifications by industry sector and on machining equipment



Upgrades
Designed to add value to the original machine investment in order to achieve higher sustainable productivity



Training
Performance-oriented academy with a human-centric approach of knowledge transfer in order to realize the full potential of our solutions



Transformation
Strategic partnership from made-to-measure advice on business model evolution to industrial implementation



Financial solutions
For the optimization of operating costs featuring minimal initial expenditure programs and leasing options

Our Success Packs

As a long-time partner, since 1802, we have been serving various industrial segments and have been dedicated to providing you with a first-in-class combination of services.

We have conceived our new Success Packs range for maximizing your return on investment, empowering you in your quest for success whatever your industrial profile.



Silver +
Secure
your future



Silver
Set the foundation
for growth



Bronze +
Achieve flawless
production



Bronze
Get back on
track fast



Technical data



Machine			Mikron MILL S 400	Mikron MILL S 400 U	Mikron MILL S 500
Workarea					
Longitudinal	X	mm	500	500	500
Lateral	Y	mm	450	240	450
Vertical	Z	mm	360	360	360
Swiveling axis		°	-	+110/-110	-
Rotary axis		°	-	n x 360	-
Feed rate					
Rapid traverse	X, Y	m/min	61	61	61
Rapid traverse	Z	m/min	61	61	61
Rapid traverse (swivel)		min ⁻¹	-	165	-
Rapid traverse (rotary)		min ⁻¹	-	250	-
Working spindle (40% ED, S6)					
60,000 min ⁻¹ , HSK-E32		kW / Nm	8.5 / 3.5	8.5 / 3.5	8.5 / 3.5
42,000 min ⁻¹ , HSK-E40		kW / Nm	13.5 / 8.8	13.5 / 8.8	13.5 / 8.8
30,000 min ⁻¹ , HSK-E40		kW / Nm	13.5 / 8.8	13.5 / 8.8	13.5 / 8.8
Work table					
Table		mm	-	-	590 x 450
Pallet/clamping surface		mm	Dynafix 280x280/350x350	MacroMagnum 156	-
Pallet/clamping surface		mm	UPC 320 x 320	ITS 148	-
Max. table load		kg	120	25	200
Tool magazine					
HSK-E32		tool holder	20/40	20/40	20/40
HSK-E40		tool holder	18 / 36 / 68 / 168	18 / 36 / 68 / 168	18 / 36 / 68 / 168
Automation					
Pallet size / Number		Piece	UPC/Dynafix / 7x	M.M. 156/18x	-
Pallet size / Number		Piece	-	ITS 148/20x	-
Maximum additional load		kg	90	25	-
Weight					
Machine		kg	6'800	7'000	6'800
Pallet changer		kg	900	900	-
Control unit					
Heidenhain			TNC 640	TNC 640	TNC 640



Machine			Mikron MILL S 600	Mikron MILL S 600 U	Mikron MILL S 800
Workarea					
Longitudinal	X	mm	600	800	800
Lateral	Y	mm	600	600	600
Vertical	Z	mm	500	500	500
Swivelling axis		°	-	+ 30/-110°	-
Tilting axis		°	-	n x 360°	-
Feed rate					
Rapid traverse	X, Y	m / min	61	61	61
Rapid traverse	Z	m / min	61	61	61
Rapid traverse (swivel)		rpm	-	60	-
Rapid traverse (rotary)		rpm	-	150	-
Working spindle (40% ED, S6)					
42,000 rpm, HSK-E40		kW / Nm	13.5/ 8.8	13.5/ 8.8	13.5/ 8.8
36,000 rpm, HSK-E50		kW / Nm	33 /21	33 /21	33 /21
30,000 rpm, HSK-E40		kW / Nm	13.5/ 8.8	13.5/ 8.8	13.5/ 8.8
24,000 rpm, HSK-A63		kW / Nm	28/28.2	28/28.2	28/28.2
Work table					
Table		mm	900 x 600	-	900 x 600
Pallet/clamping surface		mm	-	Dynafix 280x280/350x350	-
Pallet/clamping surface		mm	800 x 600	UPC 320 x 320	800 x 600
Max table load		kg	500	120	1000
Tool magazine					
HSK-E40		piece	18 / 36 / 68 / 168	18 / 36 / 68 / 168	18 / 36 / 68 / 168
HSK-E50		piece	15/30/60/120/170/220	15/30/60/120/170/220	15/30/60/120/170/220
HSK-A63		piece	48 / 120 / 170 / 220	48 / 120 / 170 / 220	48 / 120 / 170 / 220
Automation					
Pallet size / Number		- / piece	800 x 600/4x	UPC/Dynafix / 7x	800 x 600/4x
Max. load		kg	500	90	800
Weight					
Machine		kg	9,900	9,900	9,900
Pallet magazine		kg	900	900	1,800
Control unit					
Heidenhain			TNC 640	TNC 640	TNC 640

Mikron MILL S 400 / 400 U / 500

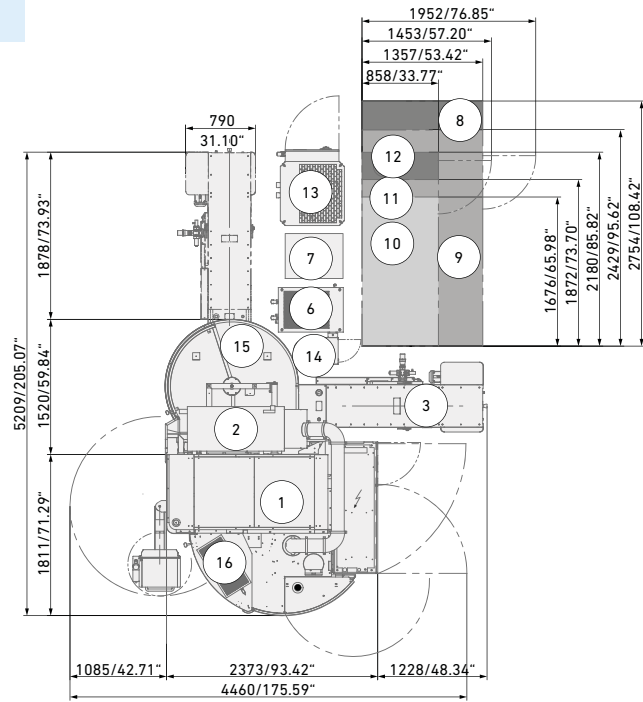
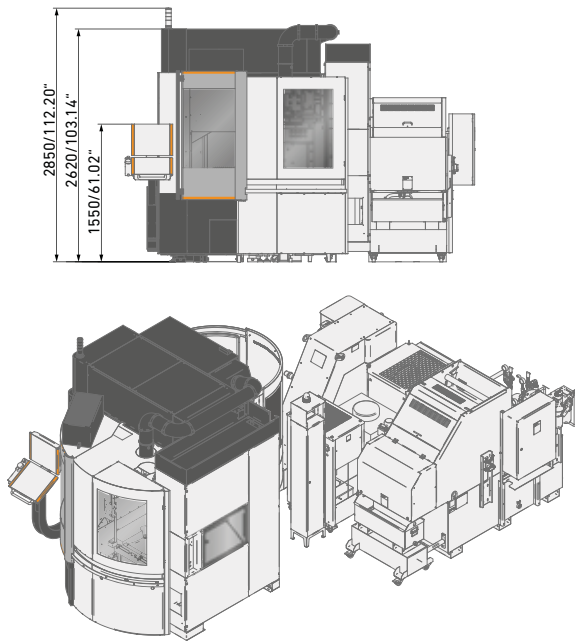

1. Machine
2. Mist extraction unit
3. Lift-up chip conveyor (scraper and slat band-type)
6. Cooling unit
7. CoolCore cooling unit
8. Endless belt filter system (950 liters)
9. Band filter system 950 liters)
10. Basket filter system 450 liters)
11. Band filter system 450 liters)
12. Endless belt filter system 450 liters)
13. Coolant thermal control
14. CO² fire extinguishing system
15. Pallet magazine
16. Pressure-relief damper

Mikron MILL S 600 / 600 U / 800

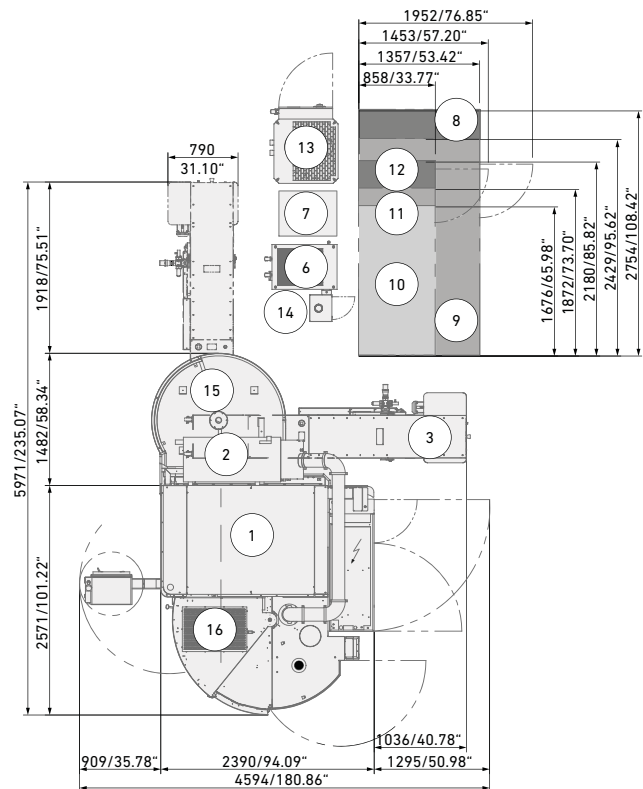
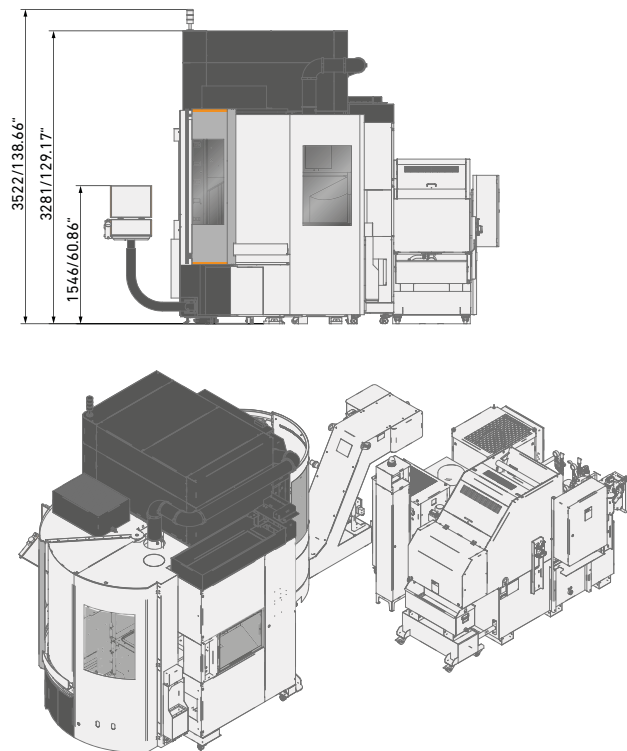

Customer Services

New digital service possibilities

GF Machining Solutions Customer Services continues to push technological boundaries to deliver the future of services to you—today.



rConnect is the digital services platform available for all GF Machining Solutions technologies. Following a modular approach, rConnect comprises a range of services that empower you to increase your manufacturing productivity. Certified with the TÜViT Trusted Product Certificate.

rConnect Messenger, we deliver machine data to your mobile device to keep you constantly informed about your production. You can supervise your workshop from your smartphone.

rConnect Live Remote Assistance (LRA), our expert engineers rapidly respond to your service requests. LRA allows effective face-to-face assistance using audio, video, chat and many more functionalities.



About GF Machining Solutions

Multi-technology solutions provider

Our commitment to you and your specific applications is proven by the value-adding intelligence, productivity and quality delivered by our multi-technology solutions. Your success is our chief motivator. That's why we are continuously advancing our legendary technical expertise. Wherever you are, whatever your market segment and whatever the size of your operation, we have the complete solutions and the customer-centric commitment to accelerate your success—today.

EDM (electrical discharge machining)



Wire-cutting EDM

GF Machining Solutions' wire-cutting EDM is fast, precise and increasingly energy efficient. From ultraprecise machining of miniaturized components down to 0.02 mm to powerful solutions for demanding high-speed machining with respect to surface accuracy, our wire EDM solutions position you for success.

Die-sinking EDM

GF Machining Solutions is revolutionizing die-sinking EDM with features like iGAP technology to dramatically boost machining speed and reduce electrode wear. All of our die-sinking systems offer fast removal and deliver mirror finishes of Ra 0.1 µm (4 µin).

Hole-drilling EDM

GF Machining Solutions' robust hole-drilling EDM solutions enable you to drill holes in electrically conductive materials at a very high speed—and, with a five-axis configuration, at any angle on a workpiece with an inclined surface.

Milling



Milling

Precision tool and mold manufacturers enjoy a competitive edge with our Mikron MILL S solutions' fast and precise machining. The Mikron MILL P machines achieve above-average productivity thanks to their high performance and Automation. Customers seeking fastest return on investment benefit from the affordable efficiency of our MILL E solutions.

High Performance Airfoil Machining

Our Liechti turnkey solutions enable the highly dynamic manufacturing of precision airfoils. Thanks to their unique performance and our expertise in airfoil machining, you increase productivity by producing at the lowest cost per part.

Spindles

As part of GF Machining Solutions, Step-Tec is engaged in the very first stage of each machining center development project. Compact design combined with excellent thermal and geometric repeatability ensure the perfect integration of this core component into the machine tool.

Advanced manufacturing



Laser texturing

Aesthetic and functional texturing is easy and infinitely repeatable with our digitized Laser technology. Even complex 3D geometries, including precision parts, are textured, engraved, microstructured, marked and labeled.

Laser micromachining

GF Machining Solutions offers the industry's most complete line of Laser micromachining platforms optimized for small, high-precision features to meet the increasing need for smaller, smarter parts to support today's leading-edge products.

Laser Additive Manufacturing (AM)

GF Machining Solutions and 3D Systems, a leading global provider of additive manufacturing solutions and the pioneer of 3D printing, have partnered to introduce new metal 3D printing solutions that enable manufacturers to produce complex metal parts more efficiently.

Tooling and Automation



Tooling

Our customers experience complete autonomy while maintaining extreme accuracy, thanks to our highly accurate System 3R reference systems for holding and positioning electrodes and work pieces. All types of machines can easily be linked, which reduces set-up times and enables a seamless transfer of workpieces between different operations.

Automation

Together with System 3R, we also provide scalable and cost-effective Automation solutions for simple, single machine cells or complex, multi-process cells, tailored to your needs.

Software



Digitalization solutions

To drive its digital transformation, GF Machining Solutions acquired symmedia GmbH, a company specialized in software for machine connectivity. Together, we offer a complete range of Industry 4.0 solutions across all industries. The future requires the ability to adapt quickly to continual digital processes. Our intelligent manufacturing offers embedded expertise, optimized production processes, and workshop Automation: solutions for smart and connected machines.

Customer Services



Worldwide for you

Ensuring the best performance throughout the lifetime of our customers' equipment is the goal of our three levels of support. Operations Support offers the complete range of original wear parts and certified consumables. Machine Support includes spare parts, technical support, and a range of preventive services to maximize machine uptime. Business Support offers customer-specific business solutions.



Switzerland

Biel/Bienne
Losone
Geneva
Flawil
Langnau

www.gfms.com
www.gfms.com/ch

Europe

Germany, Schorndorf
www.gfms.com/de

United Kingdom, Coventry
www.gfms.com/uk

Italy, Agrate Brianza - MI
www.gfms.com/it

Spain, Sant Boi de Llobregat
Barcelona
www.gfms.com/es

France, Palaiseau
www.gfms.com/fr

Poland, Raszyn / Warsaw
www.gfms.com/pl

Czech Republic, Brno
www.gfms.com/cz

Sweden, Vällingby
www.gfms.com/system3r

Turkey, Istanbul
www.gfms.com/tr

Americas

USA
Lincolnshire, IL
Chicago, IL
Holliston, MA
Huntersville, NC
Irvine, CA
Woodridge, IL
www.gfms.com/us

Canada, Mississauga ON
www.gfms.com/us

Mexico, Monterrey NL
www.gfms.com/us

Brazil, São Paulo
www.gfms.com/br

Asia

China
Beijing, Shanghai, Chengdu, Dongguan,
Hongkong, Changzhou
www.gfms.com/cn

India, Bangalore
www.gfms.com/sg

Japan
Tokyo, Yokohama
www.gfms.com/jp

Korea, Seoul
www.gfms.com/kr

Malaysia, Petaling Jaya
www.gfms.com/sg

Singapore, Singapore
www.gfms.com/sg

Taiwan
Taipei, Taichung
www.gfms.com/tw

Vietnam, Hanoi
www.gfms.com/sg

At a glance

We enable our customers to run their businesses efficiently and effectively by offering innovative Milling, EDM, Laser, Additive Manufacturing, Spindle, Tooling and Automation solutions. A comprehensive package of Customer Services completes our proposition.

www.gfms.com

